

**Item Number**  
**Item Description**    **980nm 200um Fiber-coupled Module**

**Pilot Production Phase** <sup>2</sup>  
**ECCN: EAR99** <sup>3</sup>

	Units	Lower Spec	Typical	Upper Spec
<b>Optical</b>				
CW Output Power	W		30	
Centroid Wavelength	nm	977	980	983
Spectral Width (FWHM)	nm			4.5
Slope Efficiency	W / A		3.5	
Beam Divergence from Fiber (90% PE)	NA		0.14	0.20
Fiber Core / Clad Diameter	µm		200 / 220	
Fiber NA / Index Type	-		0.22 / PowerCore™	
<b>Electrical</b>				
Electrical-to-Optical Efficiency	%	47	52	
Threshold Current	A		0.5	
Operating Current	A		9.1	10.2
Operating Voltage	V		6.4	7.1
Series Resistance	Ω		0.2	
<b>Mechanical</b>				
Mass <sup>7</sup>	g		120	
Fiber Length	m	1.9	2.0	2.1
Fiber Bend Radius (Active / Storage)	mm		30 / 25	
Fiber Jacketing	-		Stainless Steel Squarelock	
Fiber Termination	-		SMA	
<b>Thermal</b>				
Thermal Resistance <sup>4</sup>	°C / W		1.05	
Waste Heat	W		28	
Operating Housing Temperature <sup>6</sup>	°C		+25	
Wavelength Temperature Coefficient <sup>5</sup>	nm / °C		0.35	

### Outline Drawing

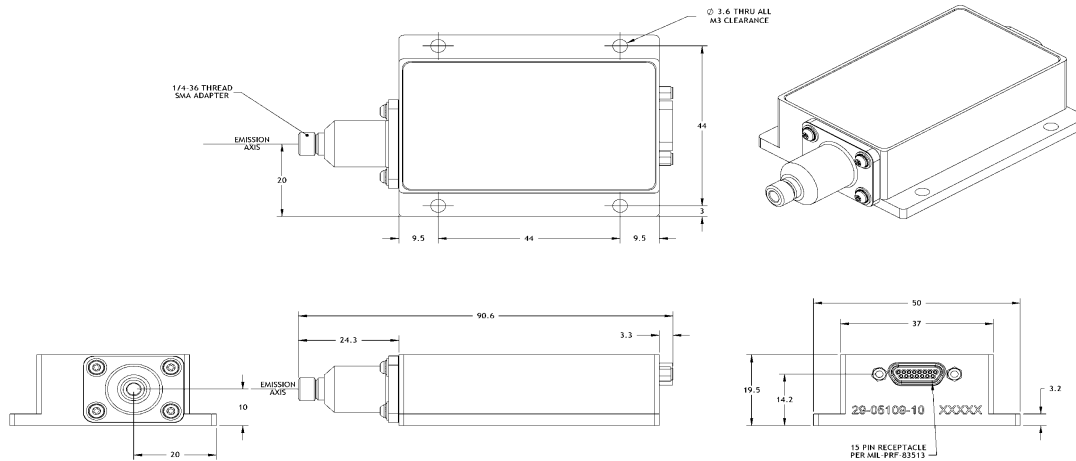

### Notes

- <sup>1</sup>Production specifications shown are for beginning of life performance, end of life operating current (lop) is 120% beginning of life lop
- <sup>2</sup>Current phase within nLIGHT's NPI (New Production Introduction) process
- <sup>3</sup>Export Control Classification Number (ECCN) as defined by the Export Administration Regulations (EAR)
- <sup>4</sup>Thermal resistance is the diode junction temperature shift per incremental Watt of heat load
- <sup>5</sup>The wavelength temperature coefficient is the wavelength shift per °C change at the diode junction
- <sup>6</sup>Operating temperature defined by the package housing. Acceptable operating range is 20 - 35C, but performance may vary
- <sup>7</sup>Does not include mass of fiber

This product is not certified in accordance with IEC 60825-1 or 21CFR1040.10/21CFR1040.11 and is solely intended to be integrated into a laser product certified by the Purchaser. The Purchaser acknowledges that their product (incorporating the nLIGHT laser product) must comply with the applicable regulations before it can be sold.



**Notice**  
nLIGHT continually improves its products to provide customers with outstanding quality and reliability, therefore may change certain specifications and product descriptions at any time, without notice. Additionally, nLIGHT offers a limited warranty to ensure customer satisfaction. For complete details, please contact an nLIGHT sales representative.



nLight Corporation  
5408 NE 88th Street, Bldg E  
Vancouver, Washington 98665  
United States of America  
Phone: 866.202.4488  
360.566.4460  
Fax: 360.546.1960  
e-mail: sales@nlight.net  
Web: www.nlight.net